

**inRAIL** **ALU**

**ALLUMINIO - ALUMINIUM  
ALUMINIUM - ALUMINIO**



**MAX 100 KG**

**TUV SUD**

**GS** geprüfte Sicherheit

TESTATO E CERTIFICATO - TESTED AND APPROVED  
GEPÜFT UND ZERTIFIZIERT

Misura / Size / Größe

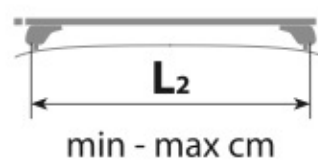
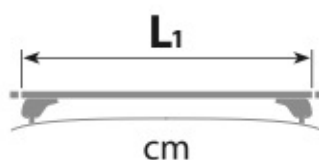

Art. **N15054**



**108**

**75 - 103**

Art. **N15055**



**120**

**99 - 115**

Art. **N15056**



**127**

**106 - 122**



**S** Art. N15054 3,0Kg.

**M** Art. N15055 3,5Kg.

**XL** Art. N15057 4,5Kg.



TESTATO E CERTIFICATO  
TESTED AND APPROVED  
GEPÜFT UND ZERTIFIZIERT

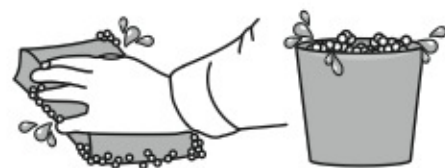
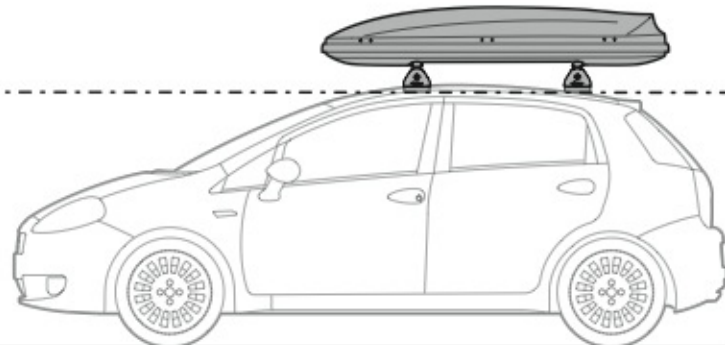

Safety Regulations

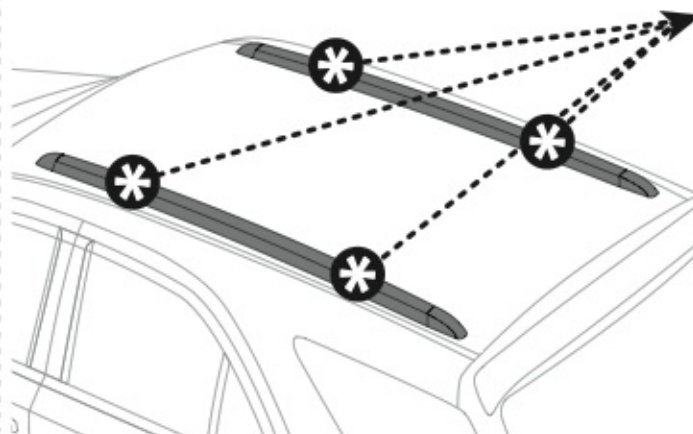

**A**

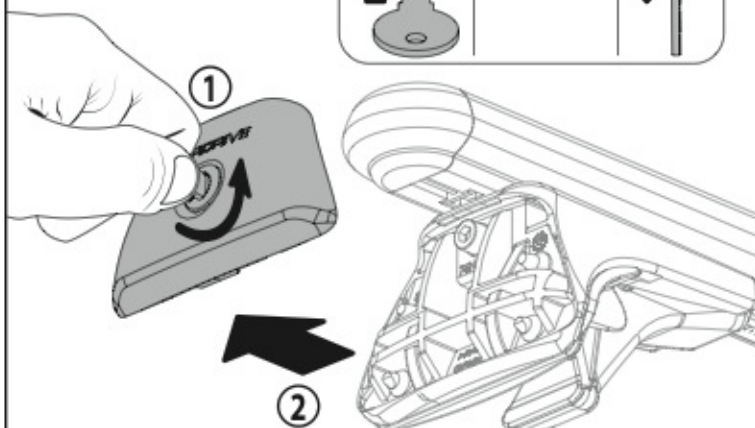
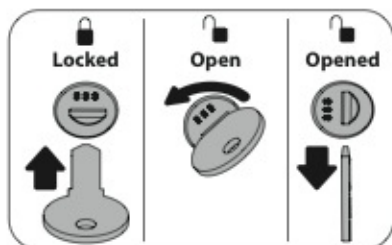

**B**

